



Molecular Property Spectrometer™ MPS™ Flammable Gas Sensor

OVERVIEW

NevadaNano's MPS Flammable Gas Sensor is the next generation of gas detection and quantification for worker safety and leak detection in drilling, transportation, and production of oil & gas and chemical products. The smart sensor quickly detects and accurately quantifies over a dozen gases and gas mixtures using a standard factory calibration. It has built-in environmental compensation and automatic self-testing for fail-safe operation. It is intrinsically safe, robust, and extremely poison resistant. Sensor readings are output on a digital bus or configurable analog output – no added electronics are required. With calibration-free operation for 5+ years, the MPS Flammable Gas Sensor delivers industry-leading performance and a low cost of ownership.

TrueLEL™ GAS DETECTION

Gas	Formula	Detection Range	Accuracy (0-50 %LEL)
butane	C ₄ H ₁₀	0-100 %LEL	±5 %LEL
ethane	C ₂ H ₆	0-100 %LEL	±5 %LEL
hydrogen	H ₂	0-100 %LEL	±5 %LEL
isobutane	HC(CH ₃) ₃	0-100 %LEL	±5 %LEL
isobutylene	C ₄ H ₈	0-100 %LEL	±5 %LEL
isopropanol	C ₃ H ₈ O	0-100 %LEL	±10 %LEL
methane	CH₄	0-100 %LEL	±3 %LEL
methyl ethyl ketone	C ₄ H ₈ O	0-100 %LEL	±5 %LEL
octane	C ₈ H ₁₈	0-100 %LEL	±5 %LEL
pentane	C ₅ H ₁₂	0-100 %LEL	±5 %LEL
propane	C ₃ H ₈	0-100 %LEL	±6 %LEL
propylene	C ₃ H ₆	0-100 %LEL	±5 %LEL
toluene	C ₇ H ₈	0-100 %LEL	±12 %LEL
xylene	C ₈ H ₁₀	0-100 %LEL	±12 %LEL

Accuracy guaranteed for methane and hydrogen across full environmental range. Other gases will typically meet the published tolerances across the full environmental range, but are guaranteed only near standard conditions¹. The MPS Flammable Gas Sensor is capable of detecting most common flammable gases/vapors (see page 4). Contact info@nevadanano.com for more information.

PERFORMANCE

Resolution	0.1 %LEL
Response time (T90)	< 20 seconds
Calibration	Factory calibrated

ENVIRONMENTAL OPERATING RANGE

Temperature	-40 to 75 °C
Humidity	0 to 100 %RH
Pressure	80 to 120 kPa

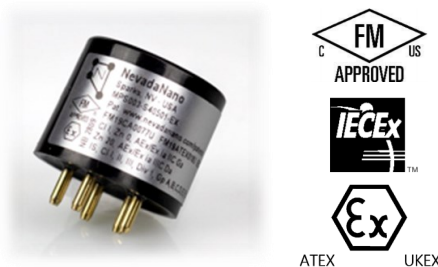

FEATURES

- Automatic multi-gas accuracy in real-time
- Built-in environmental compensation
- Extremely poison resistant
- No calibration required
- Supports 15+ year lifetimes
- Low power — 29 mW average
- Intrinsically safe (IS) certified
- Built-in self-test for fail-safe operation

OPERATING PRINCIPLE

The MPS Flammable Gas Sensor's transducer is a micro-machined membrane with an embedded Joule heater and resistance thermometer. The MEMS transducer is mounted on a PCB and packaged inside a rugged enclosure open to ambient air. Presence of a flammable gas causes changes in the thermodynamic properties of the air/gas mixture that are measured by the transducer. Sensor data are processed by patented algorithms to report an accurate concentration and classify the flammable gas.

NOTES

¹ Standard conditions: 20 °C, 50 %RH

SM-DS-0003-20

GAS CLASSIFICATION

The old way: Conventional sensing technologies (e.g. catalytic bead, NDIR) use a “k-factor” multiplier to convert raw sensor signals to gas concentrations in % LEL. These “k-factors” are based on known relative sensitivities of these sensors to different gases. A single “k-factor”, corresponding to a particular gas, must be selected manually during system setup; if the sensor is then exposed to a gas other than the one selected, significant errors in reported concentration can occur.

The MPS way: The MPS Flammable Gas Sensor applies a real-time conversion factor automatically, using the latest measured thermal properties of the ambient air/gas and the environmental conditions. The %LEL values reported for the bulk, which may contain a mixture of gases, achieves the same high levels of accuracy achieved with single gases.

The sensor also automatically outputs the class of flammable gas present, according to the following categories:

CLASS 1: Hydrogen

Molecular Weight: 2.0 [g/mol]
Density: 0.09 [kg/m³]
Number of Carbons: 0



CLASS 2: Hydrogen Mixture

Avg. Mol. Weight: 1-14 [g/mol]
Avg. Density: 0.1-0.6 [kg/m³]
Number of Carbons: varies

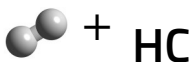

This classification is unique as it guarantees the presence of hydrogen and another flammable gas

CLASS 3: Methane/Natural Gas

Avg. Mol. Weight: 16 to 19 [g/mol]
Avg. Density: 0.6-0.9 [kg/m³]
Typical Number of Carbons: 0-2

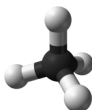

Gases having molecular properties similar to that of methane may be classified as methane (e.g. ammonia, acetylene)

CLASS 4: Light Gas (or Light Gas Mixture)

Avg. Mol. Weight: 25 to 75 [g/mol]
Avg. Density: 1.2-2.5 [kg/m³]
Typical Number of Carbons: 1-4
Example Gases: Ethane, Propane, Isopropanol

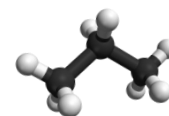

CLASS 5: Medium Gas (or Medium Gas Mixture)

Avg. Mol. Weight: 50 to 120 [g/mol]
Avg. Density: 1.5-4.0 [kg/m³]
Typical Number of Carbons: 2-8
Example Gas: Pentane

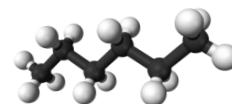

CLASS 6: Heavy Gas (or Heavy Gas Mixture)

Avg. Mol. Weight: 80+ [g/mol]
Avg. Density: 3.5+ [kg/m³]
Typical Number of Carbons: 6+
Example Gases: Octane, Toluene, Xylene

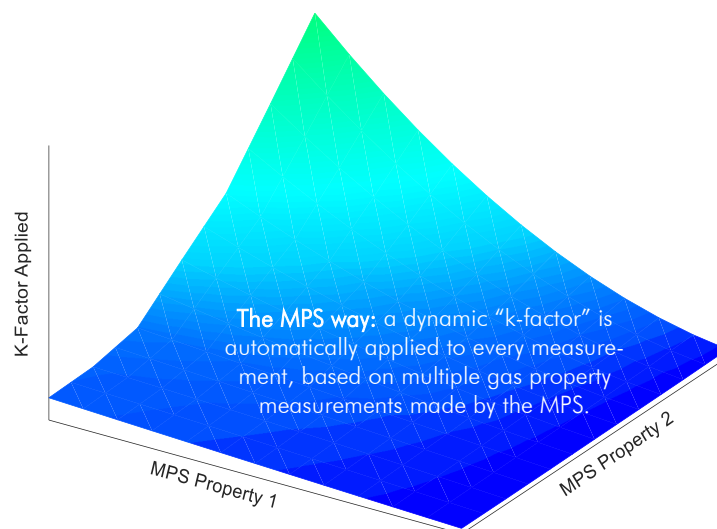
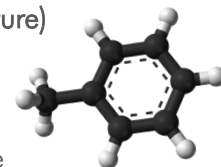

MECHANICAL

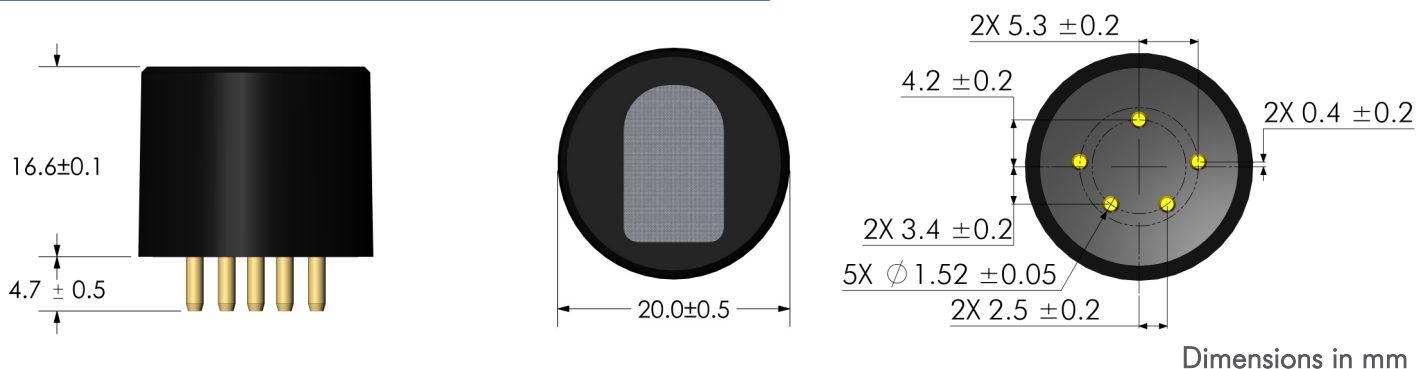

Dimensions 16.6 mm (H) x 20.0 mm (D)

Mass 8.0 ± 0.5 grams

Body material Ultem PEI

ELECTRICAL

Operating voltage 3.3 - 5.0 ±5% VDC

Current consumption

Average

8.9 mA

Operating Range

5.0-21.0 mA

5-pin
Digital Input/Output

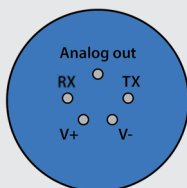

Bottom View

3-pin Pellistor Replacement
Programmable Output

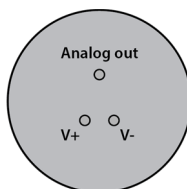

Bottom View

Communication: UART

Logic signaling standard: 3.3 V

Baud rate: 38,400. 8 data, 1 stop bits. No parity.

RX Data Input : Do not exceed 3.6 V

Input High Voltage (V_{IH}) = 2.0 V minimum

Input Low Voltage (V_{IL}) = 0.85 V maximum

TX Data Output : Source / Sink 4 mA maximum

Output High Voltage (V_{OH}) = 2.45 V minimum

Output Low Voltage (V_{OL}) = 0.45 V maximum

Programmable Analog out (optional)

Industry standard 0.4 to 2.0 Volt linearized, compensated for temperature, humidity and pressure.

Alternate configurations available, with output range and "zero" configurable between 0.04 and 2.9 Volts and configurable sensitivity slope, including rising or falling Volts per %LEL. Contact NevadaNano for details.

SELF-DIAGNOSTICS

MPS Mini Flammable Gas Sensor automatically performs a comprehensive sequence of self-checks every 2 seconds to ensure fail-safe operation. The MPS alerts the user of any sensor failure or status alert.

For additional information on how to interpret and handle detected faults, refer to the MPS Flammable Gas Sensor User Manual at www.nevadanano.com/downloads

FLAMMABLE GASES DETECTED

The volume percentage (%VOL) corresponding to 100 %LEL for a given gas varies across regions and standards due to differences in criteria, including the methods used for ignition and for the determination of an explosion. The MPS Flammable Gas Sensor is factory calibrated to report %LEL concentrations in accordance to the ISO 10156 standard, and automatically achieves the accuracies indicated in the table below without any recalibration or adjustment. To instead report %LEL concentrations according to IEC60079-20-1 and companion specification EN61779, simply multiply the %LEL reported by the MPS Flammable Gas Sensor by a factor of 1.136. The accuracy levels indicated in the rightmost column will then be achieved without any further recalibration or adjustment.

Gas	Formula	Class ⁵	Detection Range [%LEL]	% Volume of gas at 100 %LEL (ISO 10156)	MPS Accuracy 0 to 50 %LEL (ISO 10156)	% Volume of gas at 100 %LEL (IEC60079-20-1)	MPS Accuracy 0 to 50 %LEL (IEC60079-20-1)
butane	C ₄ H ₁₀	4	0-100	1.8 %VOL	±5 %LEL	1.4 %VOL	±5 %LEL
ethane	C ₂ H ₆	4	0-100	3.0 %VOL	±5 %LEL	2.4 %VOL	±5 %LEL
hydrogen	H ₂	1	0-100	4.0 %VOL	±5 %LEL	4.0 %VOL	±7 %LEL
isobutane	HC(CH ₃) ₃	4	0-100	1.8 %VOL	±5 %LEL	1.3 %VOL	±9 %LEL
isobutylene	C ₄ H ₈	4	0-100	1.8 %VOL	±5 %LEL	1.8 %VOL	±5 %LEL
isopropanol	C ₃ H ₈ O	4	0-100	2.0 %VOL	±10 %LEL	2.0 %VOL	+20 %LEL
methane	CH ₄	3	0-100	5.0 %VOL	±3 %LEL	4.4 %VOL	±3 %LEL
MEK	C ₄ H ₈ O	5	0-100	1.4 %VOL	±5 %LEL	1.5 %VOL	+16 %LEL
pentane	C ₅ H ₁₂	5	0-100	1.5 %VOL	±5 %LEL	1.1 %VOL	±6 %LEL
propane	C ₃ H ₈	4	0-100	2.1 %VOL	±6 %LEL	1.7 %VOL	±8 %LEL
propylene	C ₃ H ₆	4	0-100	2.4 %VOL	±5 %LEL	2.0 %VOL	±5 %LEL
acetone	C ₃ H ₆ O	5	0-100	2.5 %VOL	+20 %LEL	2.5 %VOL	+24 %LEL
ethylene	C ₂ H ₄	4	0-100	2.7 %VOL	-12 %LEL	2.3 %VOL	-14 %LEL
heptane	C ₇ H ₁₆	5	0-100	1.1 %VOL	±12 %LEL	0.85 %VOL	±15 %LEL
octane	C ₈ H ₁₈	6	0-100	1.0 %VOL	±12 %LEL	0.8 %VOL	±15 %LEL
styrene	C ₈ H ₈	6	0-100	1.1 %VOL	-20 %LEL	1.0 %VOL	-17 %LEL
toluene	C ₇ H ₈	6	0-100	1.2 %VOL	±12 %LEL	1.0 %VOL	±13 %LEL
xylene	C ₈ H ₁₀	6	0-100	1.1 %VOL	±12 %LEL	1.0 %VOL	±13 %LEL

Notes:

- 1) Accuracy guaranteed for methane across full environmental range.
- 2) Other gases will typically meet published tolerances across the full environmental range, but guaranteed only near standard conditions: 20°C, 50%RH.
- 3) Accuracy (+) %LEL corresponds to a higher-than-delivered reading and Accuracy (-) %LEL corresponds to a lower-than-delivered reading.
- 4) The MPS is also confirmed to detect other gases including 1-butene, acetylene, ammonia, cyclohexane, decane, diesel, dimethyl carbonate, ethanol, gasoline, hexane, and methanol. Contact info@nevadanano.com for more information.
- 5) Refer to Gas Classification section on page 2 for value descriptions. Class values shown in table will typically be accurate across the full environmental range, but were determined near standard conditions: 20°C, 50%RH.

TYPICAL GAS PERFORMANCE CHARACTERISTICS

Accuracy to Representative Gases

Data points are averages of 10 sensors. Error bars indicate minimum and maximum readings. Note: all performance data provided was collected using standard, factory-calibrated MPS sensors. No recalibration for specific gases is necessary to achieve these results.

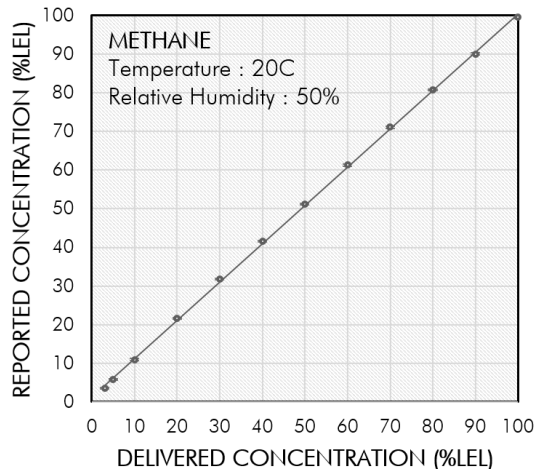
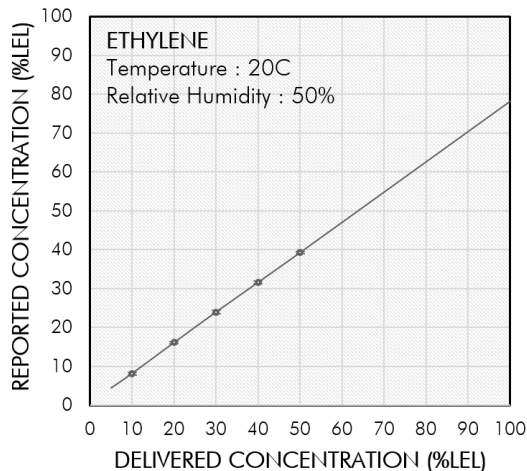
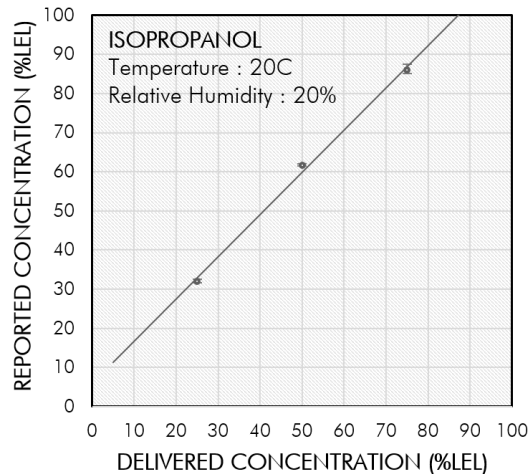
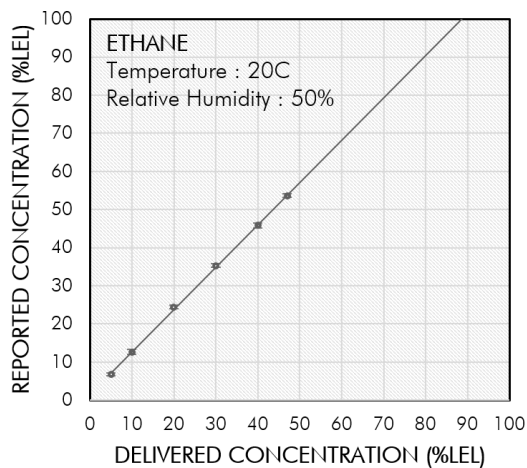
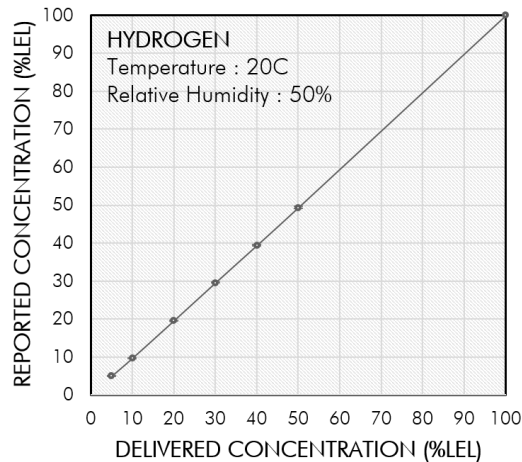
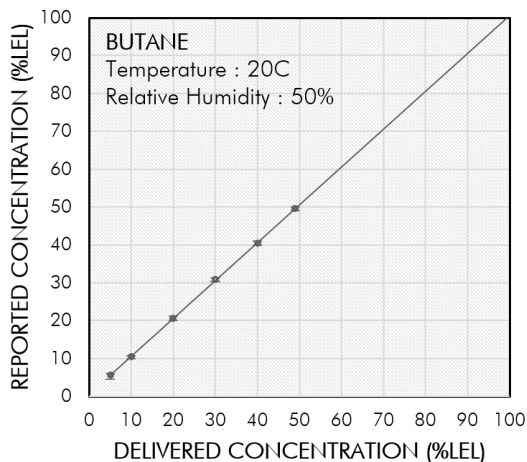

TYPICAL GAS PERFORMANCE CHARACTERISTICS

Accuracy to Representative Gases - Continued

Data points are averages of 10 sensors. Error bars indicate minimum and maximum readings. Note: all performance data provided was collected using standard, factory-calibrated MPS sensors. No recalibration for specific gases is necessary to achieve these results.

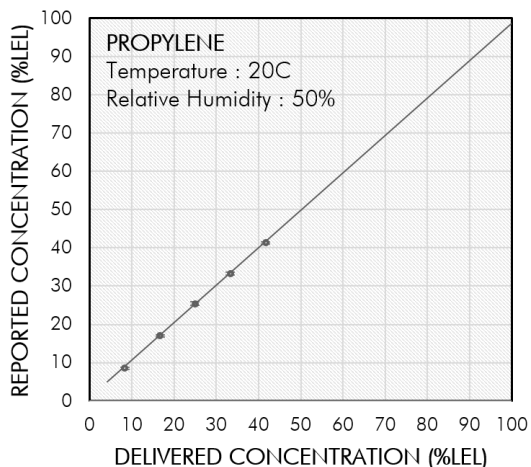
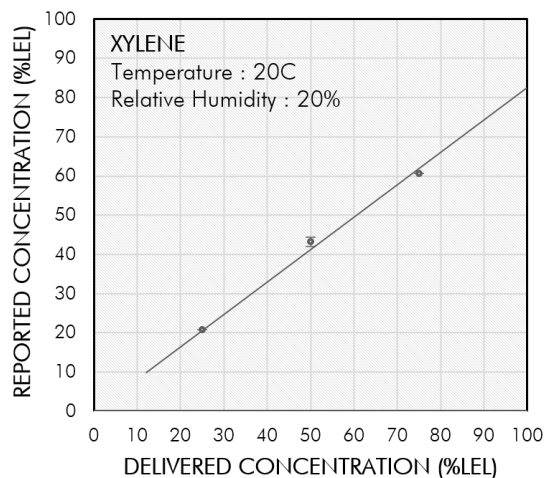
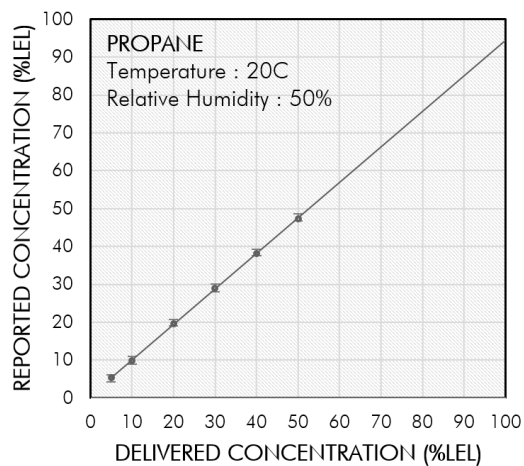
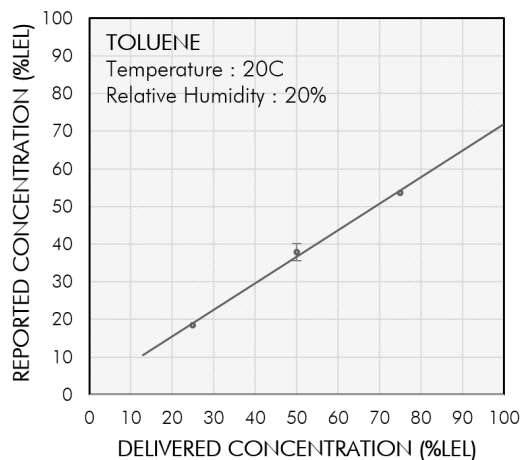
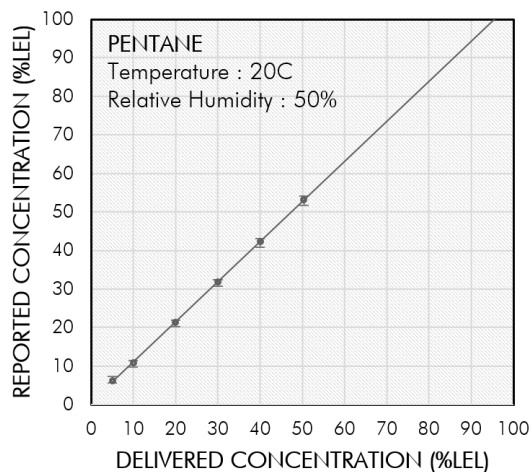

TYPICAL GAS PERFORMANCE CHARACTERISTICS

Long-Term Accuracy/Stability

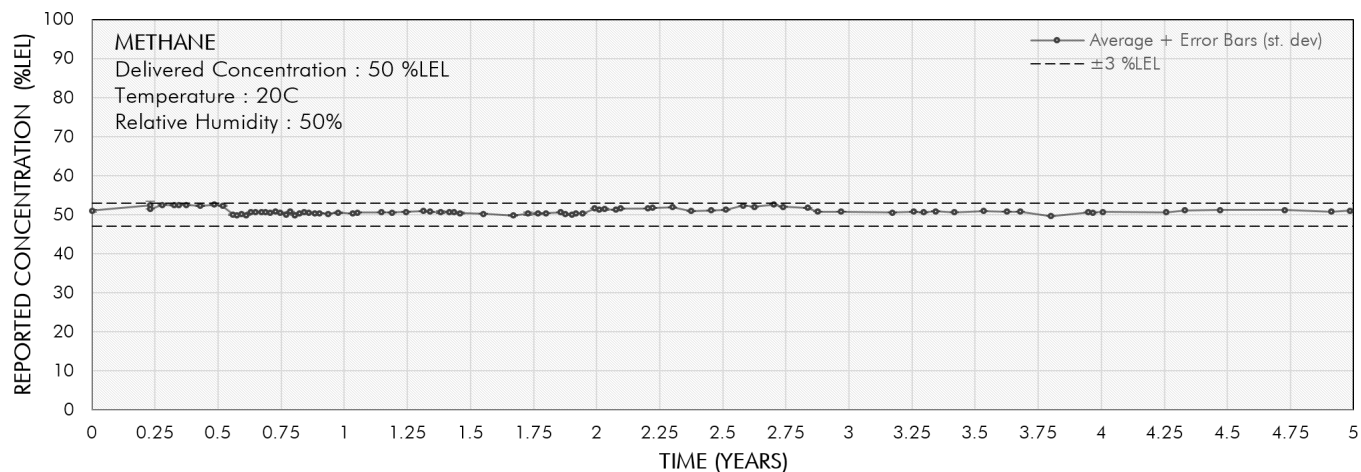

Average concentration reported to repeated exposures of 50 %LEL methane vs. time. Between exposures, all sensors were operated without airflow in ambient air. During exposures, all sensors were placed in an environmental chamber set at standard conditions (20 °C, 50 %RH) where gas was delivered from a cylinder. Accuracy remains within ±3 %LEL over 5 years.

Repeatability

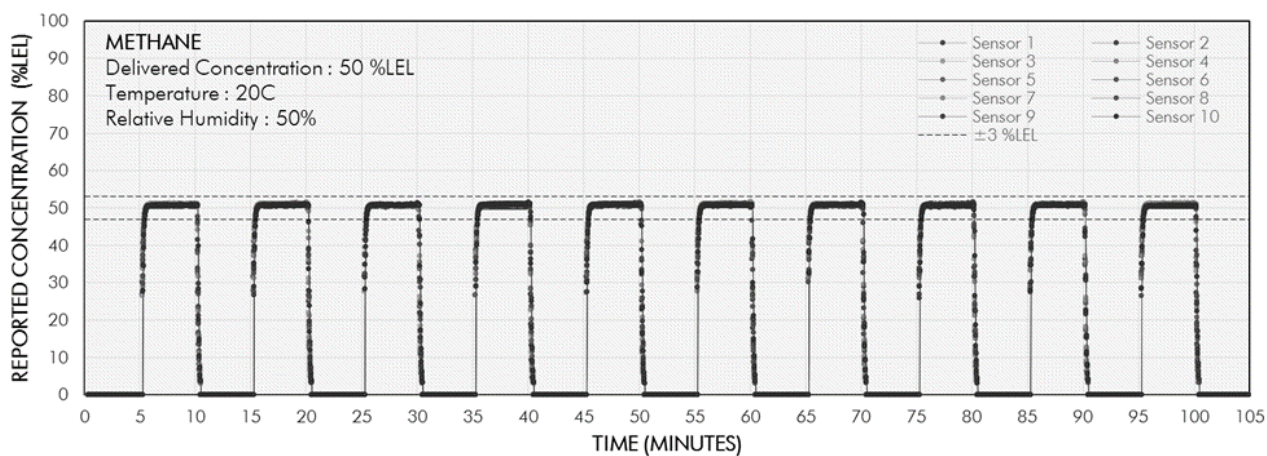

Sensor #	Average [%LEL]	Standard Deviation [%LEL]
Sensor 1	50.8	0.15
Sensor 2	50.5	0.18
Sensor 3	50.9	0.13
Sensor 4	50.7	0.22
Sensor 5	50.7	0.14
Sensor 6	50.7	0.13
Sensor 7	50.7	0.14
Sensor 8	50.6	0.18
Sensor 9	50.7	0.10
Sensor 10	50.6	0.17

Top: methane concentration reported to 10 exposures over 100 minutes by 10 MPS sensors. Bottom: table shows the averages and standard deviations of the concentrations reported during this test, by sensor. Standard deviation over 10 exposures is less than 0.25 %LEL.

SM-DS-0003-20

FLAMMABLE GASES NOT DETECTED

The MPS Flammable Gas Sensor, as currently configured, does not detect:

- **Carbon Monoxide (CO):** CO is a toxic gas, immediately dangerous to life and health (IDLH) at 1,200 ppm; the lower explosive limit is 109,000 ppm. The sensor is immune to poisoning by CO.
- **Hydrogen Sulfide (H₂S):** H₂S is a toxic gas, immediately dangerous to life and health (IDLH) at 100 ppm; the lower explosive limit is 40,000 ppm. The sensor is immune to poisoning by H₂S.

There may be other gases the sensor does not detect that have not yet been assessed or tested. For additional information about a particular flammable gas, please contact NevadaNano at www.nevadanano.com.

RESPONSE TO NON-FLAMMABLE GASES

Because the MPS performs an analysis of the molecular properties of a given “air” sample, large-scale fluctuations in the relative concentrations of the components in the air can affect accuracy. False readings can occur at non-flammable gas concentration variations (from normal air) greater than about 1 %VOL (~10,000 ppm), as discussed below; accuracy of the %LEL readings can be impacted at concentration variations (from normal air) greater than about 0.1 %VOL (~1,000 ppm).





- **Oxygen (O₂):** Normal air has an O₂ concentration of 20.95% by volume. Higher ambient O₂ concentrations up to ~21.8 %VOL have little to no effect on the sensor. Concentrations exceeding this can be reported as a flammable gas at %LEL levels. The cross sensitivity is approximately 1.07 %LEL per 1 %vol O₂ (e.g., oxygen at 30 %vol in air, a 9.1 %vol enrichment, would read approximately 9.7 %LEL and be identified as Class 2 - Hydrogen Mixture). The sensor is immune to poisoning by O₂.
 - Note: if O₂ concentrations *decrease*, the sensor response will depend on what gas is displacing the oxygen. Flammable gases displace oxygen. Methane at 100%LEL (5 %VOL methane) will reduce oxygen's relative concentration by 1.05 %VOL in ambient air, meaning the O₂ concentration decreases from 20.9 to 19.85 %VOL. Such flammable-gas-caused O₂ depletions are already taken into account by the sensor calibration and therefore cause no unwanted effects on sensor output.
 - NevadaNano has conducted testing to demonstrate the effect of extreme oxygen depletion. A gas stream containing 2.5 %VOL methane in balance zero air was diluted using a stream containing pure nitrogen to achieve 15, 10, and 5 %VOL O₂ levels. Note that the concentration of methane decreases as pure nitrogen is introduced into the gas stream. Calculated concentrations and the %LEL reported by the MPS are shown below.

	Nitrogen [%VOL]	Oxygen [%VOL]	Methane [%VOL]	Calculated [%LEL]	MPS error [%LEL]
50 %LEL Methane in Zero Air	77.1	20.4	2.5	50.0	+1.0
Diluting with N ₂ to 15 %O ₂	83.2	15.0	1.8	36.0	-6.0
Diluting with N ₂ to 10 %O ₂	88.8	10.0	1.2	24.0	-7.0
Diluting with N ₂ to 5 %O ₂	94.4	5.0	0.6	12.0	-12.0

*Calculated %LEL assumes normal “air” as the background. Actual %LEL is dictated by limiting oxygen concentration.

- **Carbon Dioxide (CO₂):** CO₂ is present at concentrations near 400 ppm in normal air. This ambient level of CO₂ is already taken into account by sensor calibrations. The sensor is unaffected by elevated CO₂ concentrations up to approximately 5,000 ppm. Concentrations above this can be misinterpreted by the sensor as flammable gas. The cross sensitivity is approximately 1.74 %LEL per 1,000 ppm CO₂ (e.g., CO₂ at 10,000 ppm would read approximately 17.4 %LEL). The sensor is immune to poisoning by CO₂.
 - Note: Exhaled human breath contains CO₂ at concentrations of approximately 4-5 %VOL (40,000-50,000 ppm). (During respiration, the CO₂ replaces oxygen, reducing its concentration from 20.95% by volume in normal air to 13.6-16% in exhaled air.) **As such, breathing directly onto the sensor can cause it to falsely report flammable gas for a brief period.**

CERTIFICATION

Certification Body			
		ATEX NB 2809	UKEX AB 1725
Test Standard	IEC 60079-0:2017 IEC 60079-11:2011	EN 60079-0:2018 EN 60079-11:2012	FM 3600:2018 FM 3610:2018 ANSI/UL 913:2019
Protection Categories	Ex ia IIC Ga Ex ia IIIC Da Ta = -40°C to 75°C	 II 1 G Ex ia IIC Ga  II 1 D Ex ia IIIC Da Ta = -40°C to 75°C	Class I, Division 1, Group A,B,C,D Class II and III, Division 1, Group E,F,G Class I, Zone 0 AEx ia IIC Ga Zone 20 AEx ia IIIC Da Ta = -40°C to 75°C
Certificate	IECEX FMG 19.0028U	FM19ATEX0184U FM21UKEX0159U	FM19US0145U FM19CA0077U

For additional information on certifications, refer to the MPS Hazardous Locations User Guide here: www.nevadanano.com/downloads

Certificates of Compliance	Specification	Test Lab/Certification Body	Certificate/Report Number
Certificate of Registration of Quality Management System	ISO 9001:2015	National Standards Authority of Ireland (NSAI)	19.8213
IECEX Quality Assessment Report	IEC 80079-34:2018	FM Approvals LLC	GB/FME/QAR19.0020/00
ATEX Quality Assurance Notification	2014/34/EU	FM Approvals LLC	FM19ATEXQ0200
UK Quality Assurance Notification	UKSI 2016:1107 (as amended)	FM Approvals LLC	FM21UKQAN0168
RoHS (2 & 3) Compliant	2011/65/EU & 2015/863	Underwriters Laboratories	CETR-NNT01.1
China RoHS Compliant	SJT/T 11363 & 11364	Underwriters Laboratories	CETR-NNT01.1
REACH Compliant	EC 1907/2006 (33 & 67)	Underwriters Laboratories	CETR-NNT01.1

The certificates of compliance are available at www.nevadanano.com/downloads

ADDITIONAL TEST STANDARDS

Test	Specification	Summary of Test Conditions
Low Temperature Operating	IEC 60068-2-1	500 Hours @ -50°C
High Temperature Operating	IEC 60068-2-2	1000 Hours @ 85°C
Vibration	IEC 60068-2-6	31Hz – 150 Hz (2G acceleration), 1 hour per axis, 3 axes
Shock	IEC 60068-2-27	50G peak/11ms half sine pulse, 3 axes (positive and negative pulses)
Drop	IEC 60068-2-31	1-meter drop onto concrete
Damp heat - steady state	IEC 60068-2-78	500 hours @ 40°C/93% RH
Temperature cycling	JESD22-A104E	From -40°C to 85°C for 200 cycles
Sand/Dust	MIL-STD-810G Method 510.5	Sand: 150-850 μm SiO ₂ particle size, 23 m/s nom. velocity, 1.5 hrs @ 70°C per axis, 3 axes Dust: Red China Clay, 1.5 m/s nom. velocity, 6 hrs @ 20°C and 6 hrs @ 70°C
Poisoning	NevadaNano	1,200 ppm-hours H ₂ S (50 ppm for 24 hours) 10,400 ppm-hours siloxanes (Decamethylcyclopentasiloxane) (100 ppm for 4 hours, then 1,000 ppm for 10 hours) 0.25 ppm-hours NO ₂ (3 ppm for 5 minutes) 0.83 ppm-hours HCN (10 ppm for 5 minutes) 0.75 ppm-hours SO ₂ (9 ppm for 5 minutes) 0.17 ppm-hours Cl ₂ (2 ppm for 5 minutes) 4.17 ppm-hours NH ₃ (50 ppm for 5 minutes)
Electrostatic Discharge	JEDEC JS001-2017	Human Body Model, passed at 2 kV
EMC: Radiated Emissions	EN 55011	30 MHz to 1 GHz
EMC: RF Electromagnetic Field Immunity	IEC/EN 61000-4-3	80 MHz to 6 GHz at 10 V/m
EMC: Magnetic Immunity	IEC/EN 61000-4-8	30 A/m, 3 axes, 50 Hz and 60 Hz

The table above provides a summary of standardized tests and test conditions to which the MPS Flammable Gas Sensor has been subjected. The sensor has passed all of these tests by demonstrating performance within the MPS Flammable Gas Sensor specification both before and after each test.

PART NUMBER ORDERING GUIDE

Please refer to the following table below when ordering the MPS Flammable Gas Sensor. When ordering a MPS S4 Evaluation Kit, please specify the MPS Flammable Gas Sensor part number to be evaluated.



Manufacturer Part Number	Description
MPS003-S40501-EX	MPS Flammables Sensor, S4, 5-Pin, UART
MPS003-S40505-EX	MPS Flammables Sensor, S4, 5-Pin, UART+Analog Out
MPS003-S40509-EX	MPS Flammables Sensor, S4, 5-Pin, UART+Analog Out+Auto Start
MPS003-S40309-EX	MPS Flammables Sensor, S4, 3-Pin, Analog Out+Auto Start



Manufacturer Part Number	Description
MPS999-S40000-99	MPS S4 Evaluation Kit



Nevada Nanotech Systems Inc.
1395 Greg Street, Suite 102
Sparks, Nevada 89431
United States
Tel: +1 775 972 8943
Fax: +1 775 972 8078
info@nevedanano.com
www.nevedanano.com